

PRODUCT SPECIFICATIONS

Stainless Steel 32" x 24" x 11-1/4" 16 Gauge Mop Sink. Sink is manufactured from 16 gauge 304 Stainless Steel with a #4 Finish, Center drain placement.

Material:	304 Stainless Steel
Finish:	#4 Finish
Gauge:	16
Weight Without Packaging:	32
Number of Bowls:	1
Sink Dimensions:	32" x 24" x 11-1/4"
Bowl 1 Dimensions:	28" x 20" x 6"
Drain Size:	3-1/2" (89mm)
Drain Location:	Center



Included with Product: Stainless Steel Skirt,
3-1/2" Brass Drain

A Century of Tradition and Quality.

For more than 100 years, Elkay has been making innovative products and providing exceptional customer care. We take pride in offering plumbing products that make life easier, inspire change and leave the world a better place.

Product Compliance: ASME A112.19.3/CSA B45.4
NSF 2

Accessory: ASME A112.18.2/CSA B125.2



Sinks are listed by IAPMO[®] as meeting the applicable requirements of the Uniform Plumbing Code[®], International Plumbing Code[®], and National Plumbing Code of Canada.

[Clean and Care Manual \(PDF\)](#)

[Installation Instructions \(PDF\) - 000000737](#)

[Warranty \(PDF\)](#)

PART: _____ QTY: _____

PROJECT: _____

CONTACT: _____

DATE: _____

NOTES: _____

APPROVAL: _____

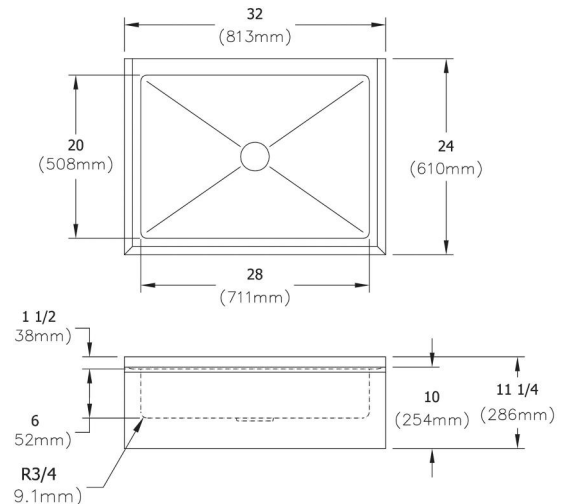

In keeping with our policy of continuing product improvement, Elkay reserves the right to change product specifications without notice. Please visit elkay.com for the most current version of Elkay product specification sheets. This specification describes an Elkay product with design, quality, and functional benefits to the user. When making a comparison of other producers' offerings, be certain these features are not overlooked.